

ELDORADO OUTDOOR™



THE BUILDING BLOCKS FOR LUXURY OUTDOOR SPACES.

ELDORADO  STONE

A HEADWATERS COMPANY



THERE'S NOTHING QUITE LIKE enjoying the pleasures of an evening dining alfresco.

Extending your living space to the outdoors is no longer just a trend, but a lifestyle worth attaining. And although an outdoor kitchen can be fulfilling, creating one can be anything but entertaining. Typically, designing and building an outdoor kitchen can involve multiple days if not weeks of messy masonry work, consuming contractor scheduling and considerable construction waste.

Eldorado Stone® is pleased to transform this process entirely with the introduction of Eldorado Outdoor™, a collection of strong, yet lightweight building blocks that quickly assemble into custom barbecue islands, kitchen counters, bars, fireplaces, fire pits and more—ready to be dressed with Eldorado Stone and Brick within hours.

Eldorado Outdoor saves time, materials and installation costs, all while allowing you to customize and design the perfect outdoor retreat.

THE INSTALLATION OF OUTDOOR SPACES SIMPLY REDEFINED...

Eldorado Outdoor products quickly assemble into a virtually limitless combination of configurations. Each piece is made of glass-fiber reinforced concrete (GFRC) which can be installed on any solid flooring surface without concrete footings or rebar. Eliminated is the construction waste and additional time

associated with traditional masonry block installs. Eldorado Outdoor products can be assembled in just hours; even cut-outs for custom features such as barbecues, sinks, drawers and burners can be done on-site.



- 1 There is no need to spend numerous hours pouring footings, laying block, bending rebar & floating the counter. Choose from numerous available sections and sizes, then install directly over existing solid surfaces. 2 All boxes have predrilled bolt holes for easy assembly. 3 4 Measure your appliances and easily cut openings right on-site. 5 Available raised backsplashes with 10" cantilevers create unique custom bar counters. 6 Accessories such as end caps simplify the construction process. 7 8 9 Eldorado Stone & Brick veneers can be installed directly to the factory scratch coat, saving prep time and materials.

ONLINE DESIGN TOOL



Made from tough glass-fiber reinforced concrete, but light enough and right-sized to transport & position anywhere for easy on-site assembly.



Now you can design the ultimate outdoor space with the **Eldorado Outdoor Online Design Tool**. It's the first step in creating your own luxurious outdoor retreat. Design your custom space by selecting from our outdoor cabinets, fireplaces, fire pits, seating walls or columns. If you need a little inspiration, choose one of our *Signature Outdoor Designs*, each of which features a complete "recipe book." Whether you have a small or large space to work with, expanding your outdoor living area has never been easier or more enjoyable. Log on to get started today:

www.eldoradostone.com/outdoor/designtool





ELDORADO OUTDOOR **Vs.** CONCRETE BLOCK

The sheer magnitude of materials, time and manpower required to build a CMU Concrete Block kitchen compared to Eldorado Outdoor is well illustrated in this “example.” Eldorado Outdoor allows you to create beautiful and authentic masonry outdoor spaces in less than half the time compared to traditional building techniques. The strong, yet lightweight material doesn't require additional concrete footings, bending rebar, or any of the mess, waste and time associated with CMU installations.

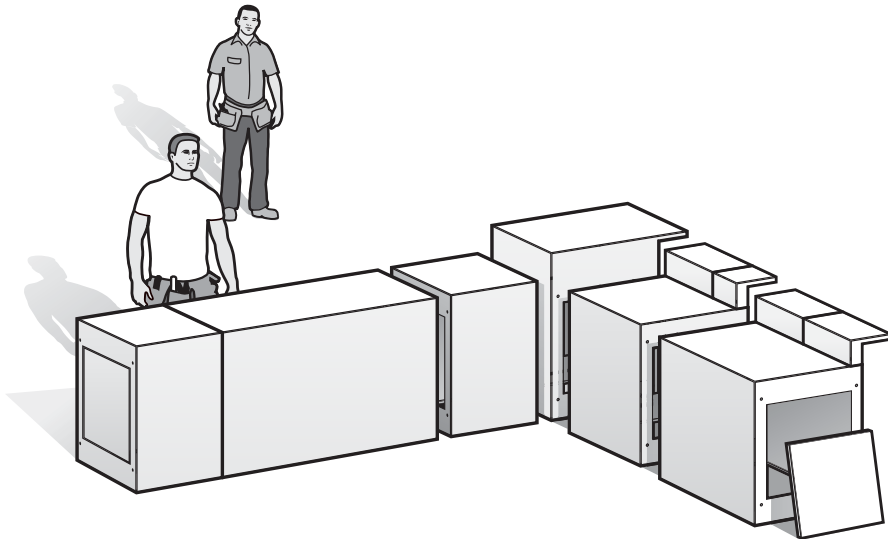

Eldorado Outdoor:

- 6 Outdoor Cabinets
- 4 Raised Backsplashes
- 2 End Caps
- Hand Tools
- 2 People
- 1 Day



CMU Concrete Block:

- 160 Qty. Concrete Blocks
- 200 Ft. Rebar
- 45 Qty. Bags of Cement
- Heavy Equipment
- 4 People
- 7 Days





ELDORADO OUTDOOR PRODUCTS: CABINETS

Eldorado Outdoor products ship complete with factory scratch coat, floated smooth top and pre-drilled bolt holes. All cabinets are open to the flooring surfaces for easy gas, electrical and water connections.

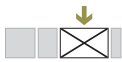

STRAIGHT (LINEAR) CABINETS

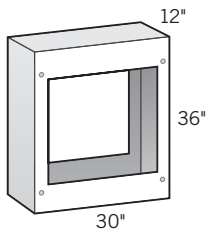

12" Cabinet
30"D x 36"H
OLPLS0012

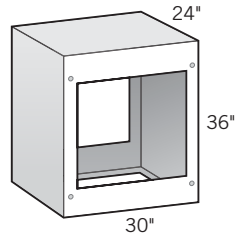

24" Cabinet
30"D x 36"H
OLPLS0024

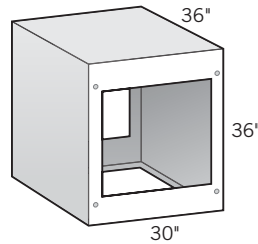

36" Cabinet
30"D x 36"H
OLPLS0036

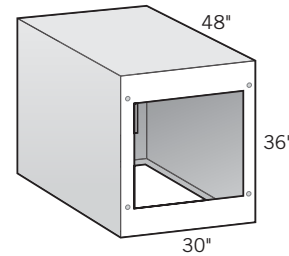

48" Cabinet
30"D x 36"H
OLPLS0048

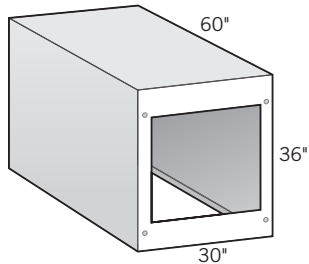

60" Cabinet
30"D x 36"H
OLPLS0060

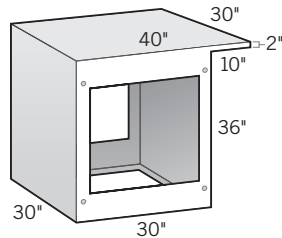

Cabinet w/10" Cantilever Backside
30"D x 30"L x 36"H
OLPLSCHBS

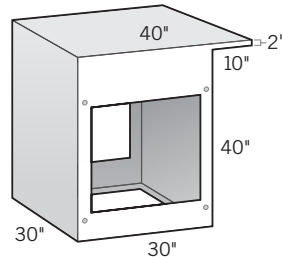

BAR-HEIGHT Cabinet w/10" Cantilever Backside
30"D x 30"L x 40"H
OLPLSBHBS



90° CORNER CABINETS

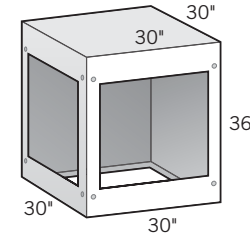

90° Corner Cabinet
30"D x 30"L x 36"H
OLPLS00CN

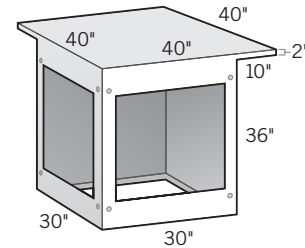

90° Corner Cabinet w/10" Cantilever on Two Sides
30"D x 30"L x 36"H
OLPLSCHBC

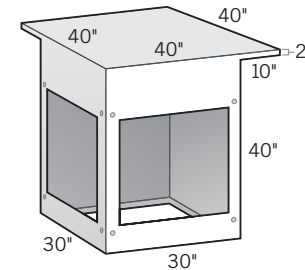

BAR-HEIGHT 90° Corner Cabinet w/10" Cantilever on Two Sides
30"D x 30"L x 40"H
OLPLSBHBC



Eldorado Outdoor is manufactured with an Integrated Factory Scratch Coat. The scratch coat eliminates any additional prep work and is ready to immediately receive stone or brick, creating a real time saver. Since the scratch coat is integral to the cabinet design, it also guarantees a consistent groove depth allowing for a very strong sheer bond between the cabinet and stone veneer.

*Cabinets feature
Eldorado Stone® Custom
Coastal Ledge*

90° RADIUS CORNER CABINETS

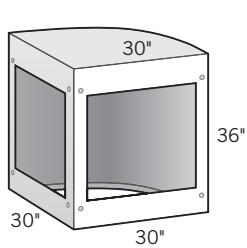

90° Radius Corner Cabinet
30"D × 30"L × 36"H
OLPLSOCHR

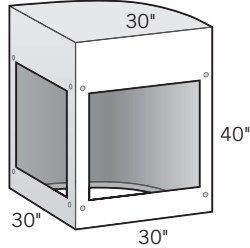

BAR-HEIGHT 90° Radius Corner Cabinet
30"D × 30"L × 40"H
OLPLSOBHR

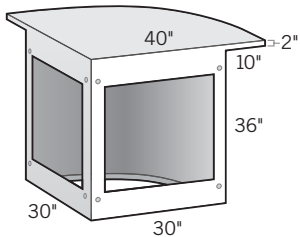

90° Radius Corner Cabinet w/10" Cantilever
30"D × 30"L × 36"H
OLPLSCHRC

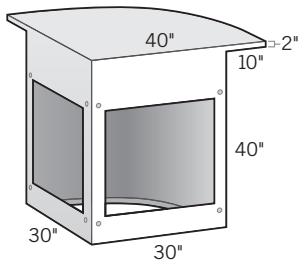

BAR-HEIGHT 90° Radius Corner Cabinet w/10" Cantilever
30"D × 30"L × 40"H
OLPLSBHRC

135° CORNER CABINETS

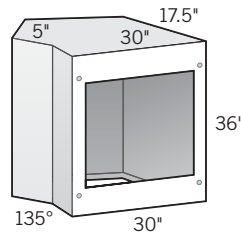

135° Radius Corner Cabinet
30"D × 36"H
OLPLSCH45

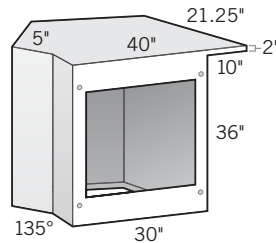

135° Radius Corner Cabinet w/10" Cantilever
30"D × 36"H
OLPLSCC45



WALLS & COLUMNS

Creating seating walls and columns in your outdoor space is easy with Eldorado Outdoor. Simply set product over solid surface and use a masonry anchor or bolt to attach to foundation (4" concrete or standard paver recommended).

SEATING WALLS

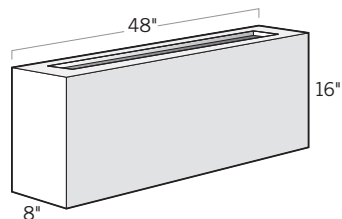

Straight Seating Wall

8"D x 48"L x 16"H

Create seating walls in hours vs. days. Finish with Eldorado Stone & Wall Caps for an authentic masonry appearance. OLPW81648

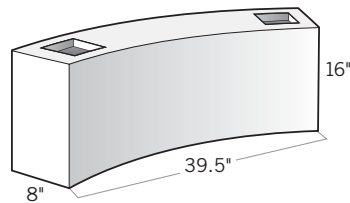

Curved Seating Wall (1/8 Circle)

8"D x 39.5"L x 16"H

Curved seating wall is designed with a 51" radius from the center point to the inside edge, perfect for pairing with our round fire pit. OLPW81640

COLUMN

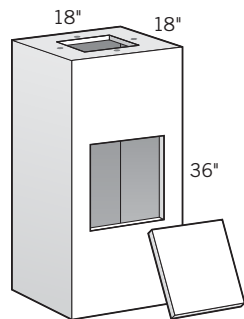

Column with End Cap

18"D x 18"L x 36"H

Instantly build perfect stone or brick columns. Column ships with access panel. Designed with top and bottom flange for attaching masonry anchor or bolting. OLPPLS1836

*Columns feature
Eldorado Stone® Custom
Coastal Ledge*





ACCESSORIES

Eldorado Outdoor accessories serve as the finishing details to complete your outdoor design. Accomplish custom features such as raised backsplashes and bar counters with ease. Accessories are readily available at all Eldorado Outdoor distributors.

RAISED BACKSPLASHES WITH CANTILEVERS

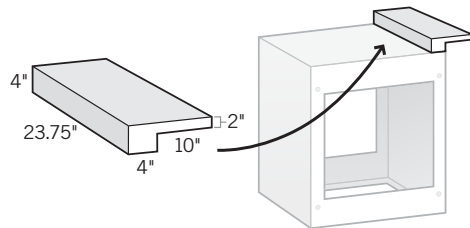

Straight Raised Backsplash

Creates 4"H raised backsplash (23.75"L) with 10" cantilever and 14" counter surface. Requires 3 bolts for mounting (not included). OLPLSBSTR

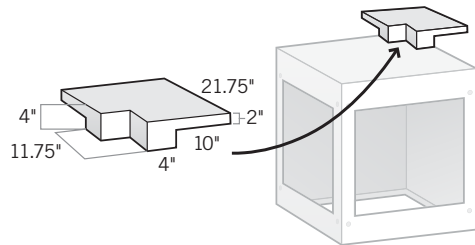

Corner Raised Backsplash

Creates 4"H raised corner backsplash with 10" cantilever; connects to Straight Raised Backsplash for L-shaped configurations. Requires 2 bolts for mounting (not included). OLPLSBCRN

EDGE DETAIL

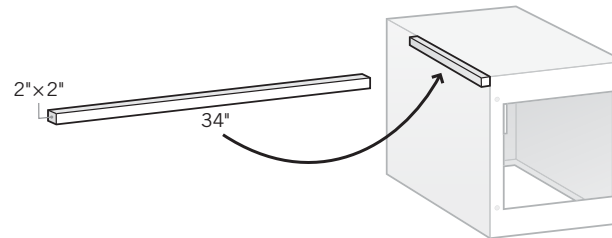

Straight Edge Detail

2"D x 2"H x 34"L. Easily cuts to surround outside edge of assembled island to create overhang for countertop (i.e. tile), creates transition for stone/brick veneer. Requires 3 bolts for mounting (not included). OLPLSEGE

CABINET END CAP

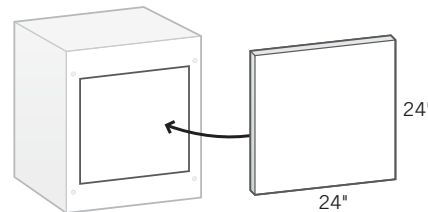

Cabinet End Cap

24" x 24" square. End caps complete the installation by closing off openings on either end of assembled island. OLPLSECAP

BRACKET & FASTENER SETS, VENTS

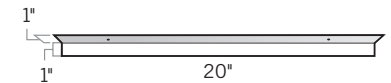

Appliance Bracket Set

Includes 2 brackets & screws for use with drawers, doors, etc. Works with flanges to secure items in cabinet cut-outs. OLPLSAB02

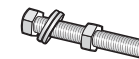

Fastener Set

Includes 4 nuts, 4 bolts & 8 washers. One fastener set is required to secure two cabinets. OLPLSF004

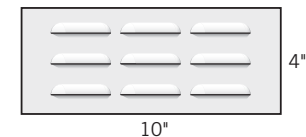

Vent

Vents are recommended by many barbecue appliance manufacturers when installing gas appliances into a closed cabinet. 01000VENT

FIREPLACES & FIRE PIT

Sitting fireside in your backyard has never been easier when you select an outdoor fireplace from Eldorado Outdoor. Fireplaces and fire pit feature our integrated scratch coat, ready to be dressed with Eldorado Stone or Brick for the ultimate masonry appearance.

FIREPLACE

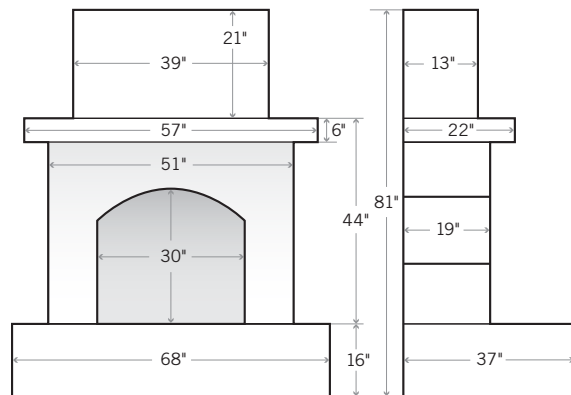

Fireplace
OLPLSFPO1

FIRE PIT

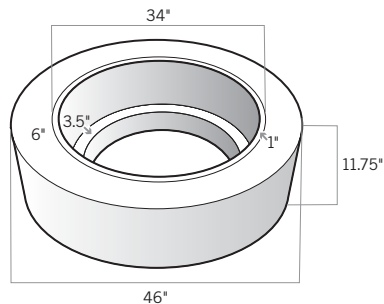

Fire Pit
OLPLSFP48

FIREPLACE EXTENSIONS

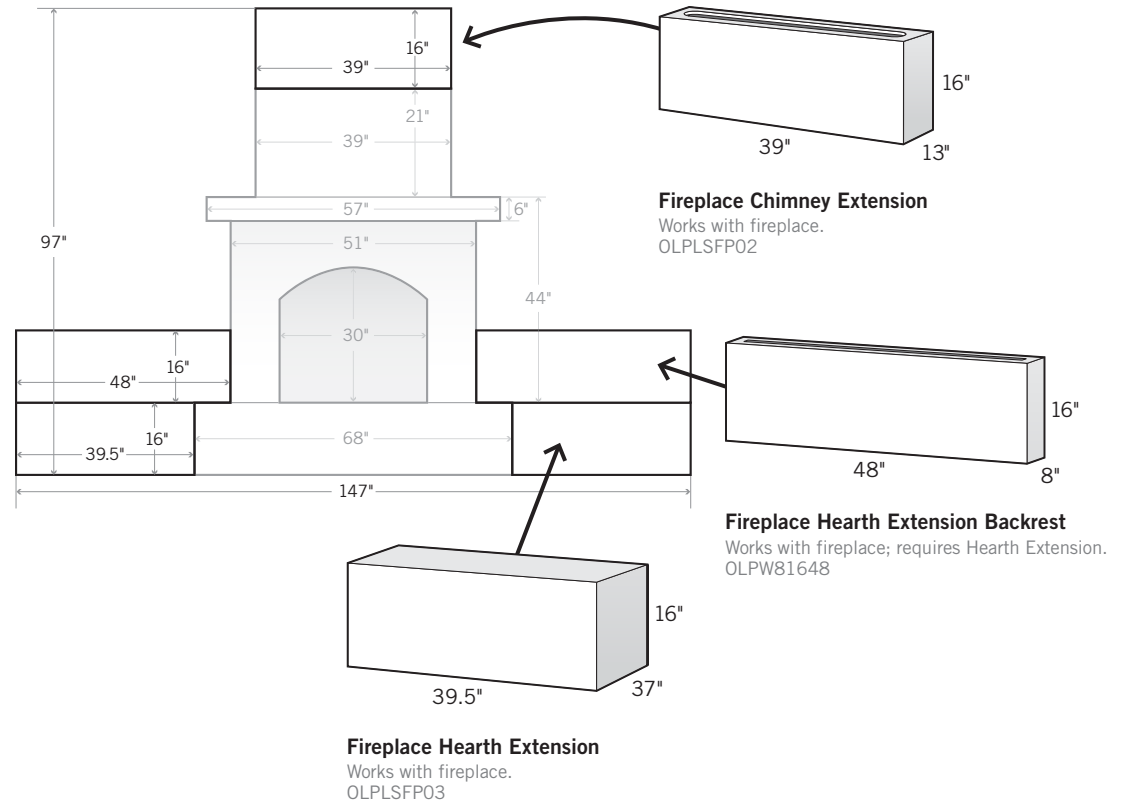

Fireplace Chimney Extension
Works with fireplace.
OLPLSFPO2

Fireplace Hearth Extension Backrest
Works with fireplace; requires Hearth Extension.
OLPW81648

Fireplace Hearth Extension
Works with fireplace.
OLPLSFPO3

Fireplace dressed with natural stone veneer; Columns feature Eldorado Stone® Custom Coastal Ledge



Cabinets feature Eldorado Stone®
Black River Stacked Stone

ELDORADO OUTDOOR™

THE BUILDING BLOCKS FOR LUXURY OUTDOOR SPACES.

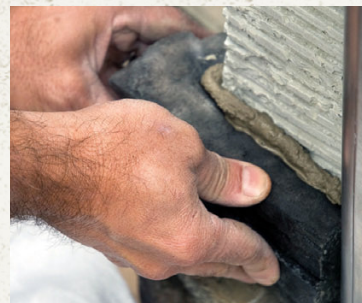

A HEADWATERS COMPANY





A HEADWATERS COMPANY

For more information and to find a distributor near you, please visit

www.eldoradostone.com/outdoor

or call 800.925.1491.



ELDORADO OUTDOOR IS EXCLUSIVELY MANUFACTURED BY OLP.